

SPECIFICATION

Part No.	: TI.16.5F11
Product Name	: 915MHz 5dBi Outdoors Omni-Directional Rigid Whip Antenna
Feature	: Stable performance at 902 MHz to 928MHz Omni-directional pattern in the azimuth Robust Weatherproof Brass Whip and Casing High Efficiency N-type Male Connector RoHS compliant

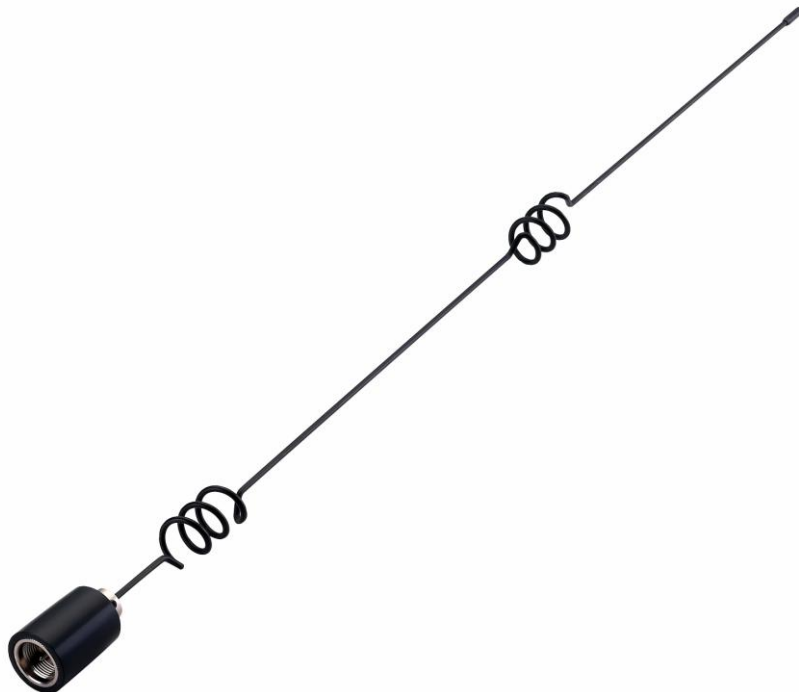

I. Introduction

TI.16 is a 5dBi 915MHz ISM band (902MHz to 928MHz) Dipole Omni-directional antenna. This robust whip is suitable for outdoors applications where wide coverage is required especially in the azimuth plane, including metering, remote monitoring. As standard low frequency monopole antenna, its radiation property improves with mounting on metal plate. Connector can be customized on request.

II. Specification Table

ISM 915MHz				
Frequency (MHz)		900	915	925
Peak Gain (dBi)	Free Space	-2.3	-1.7	-1.27
	Ground (30x30cm)	-1.1	-0.3	0.2
	Ground (50x50cm)	3.9	4.6	4.9
Average Gain (dBi)	Free Space	-7.2	-6.8	-6.4
	Ground (30x30cm)	-6.0	-5.2	-4.6
	Ground (50x50cm)	-3.1	-2.2	-1.7
Efficiency	Free Space	19%	21%	22%
	Ground (30x30cm)	25%	30%	35%
	Ground (50x50cm)	49%	60%	68%
Impedance		50Ω		
Polarization		Linear		
Radiation Pattern		Omni		
Input Power		50 W		
MECHANICAL				
Dimensions		620mm		
Base Diameter		25mm		
Whip Diameter		19mm at widest		
Whip Material		Coated Brass		
Connector		N Male Straight		
ENVIRONMENTAL				
Temperature Range		-40°C to 85°C		
Humidity		Non-condensing 65°C 95% RH		

III. Antenna Characteristics

III.1. Return Loss

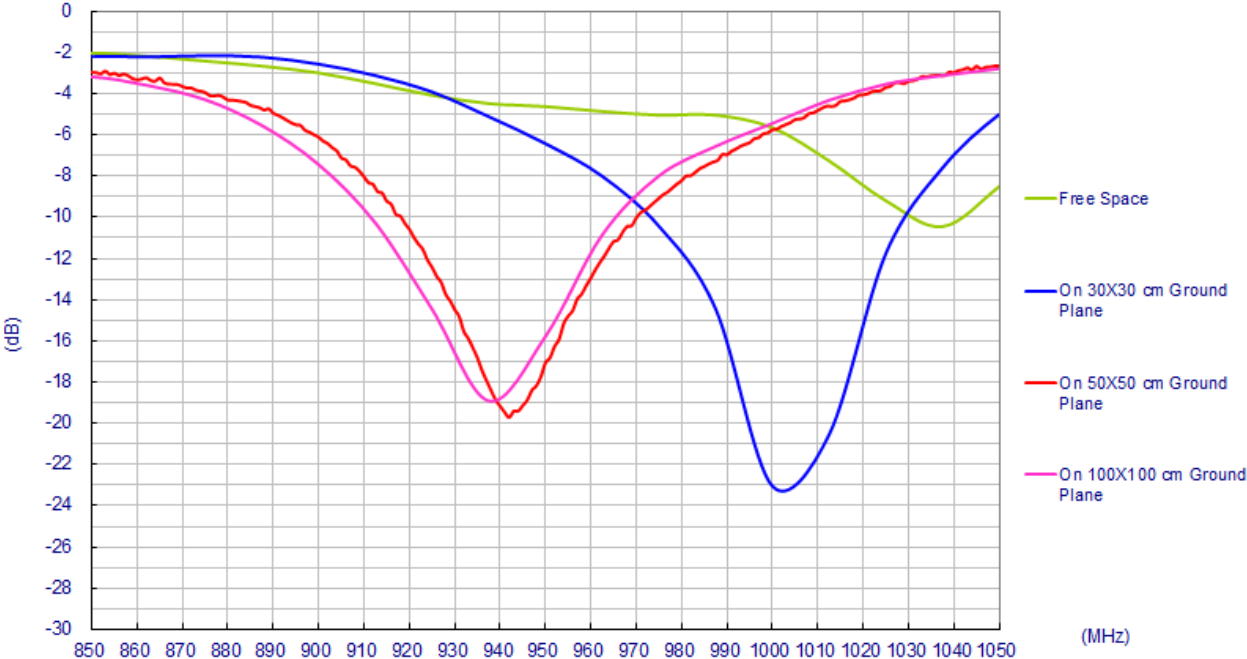

III.2. Antenna Efficiency

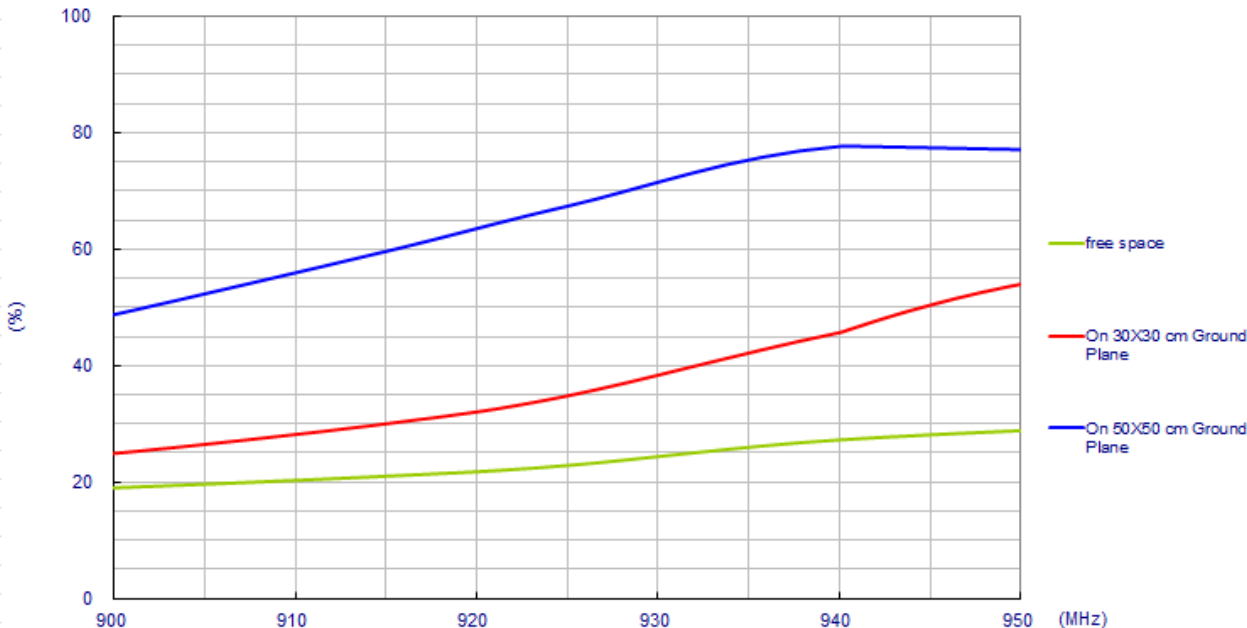

III.3. Peak Gain

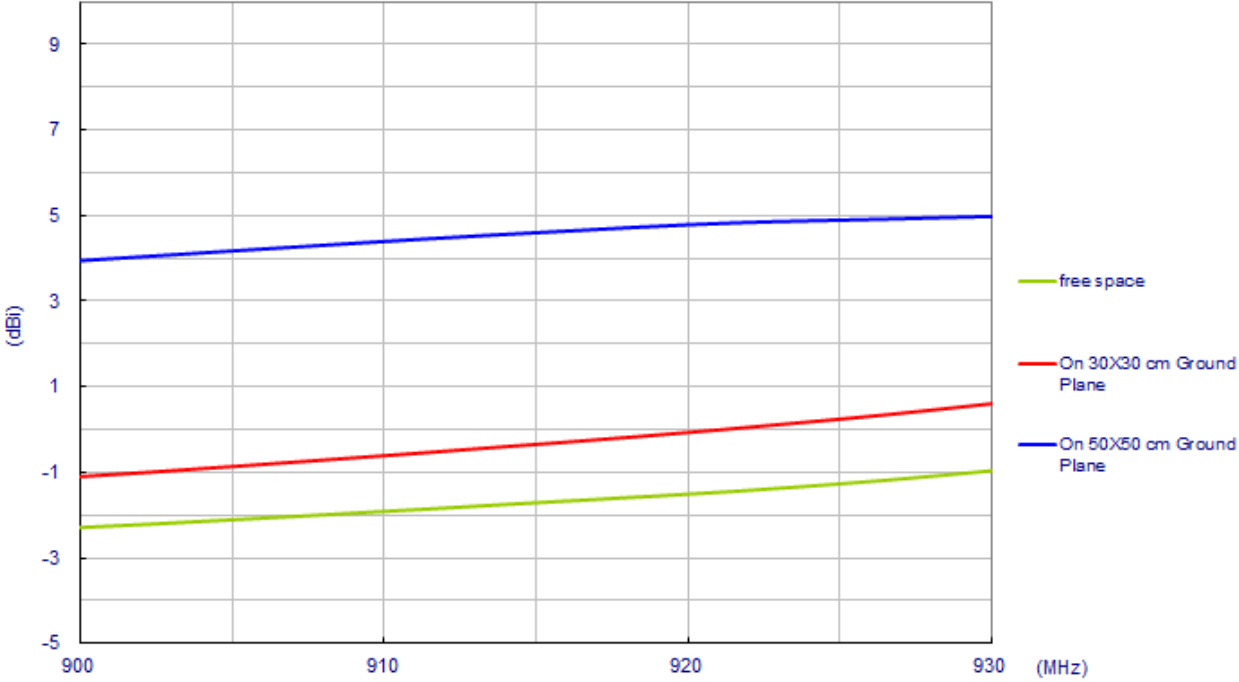

III.4. Average Gain

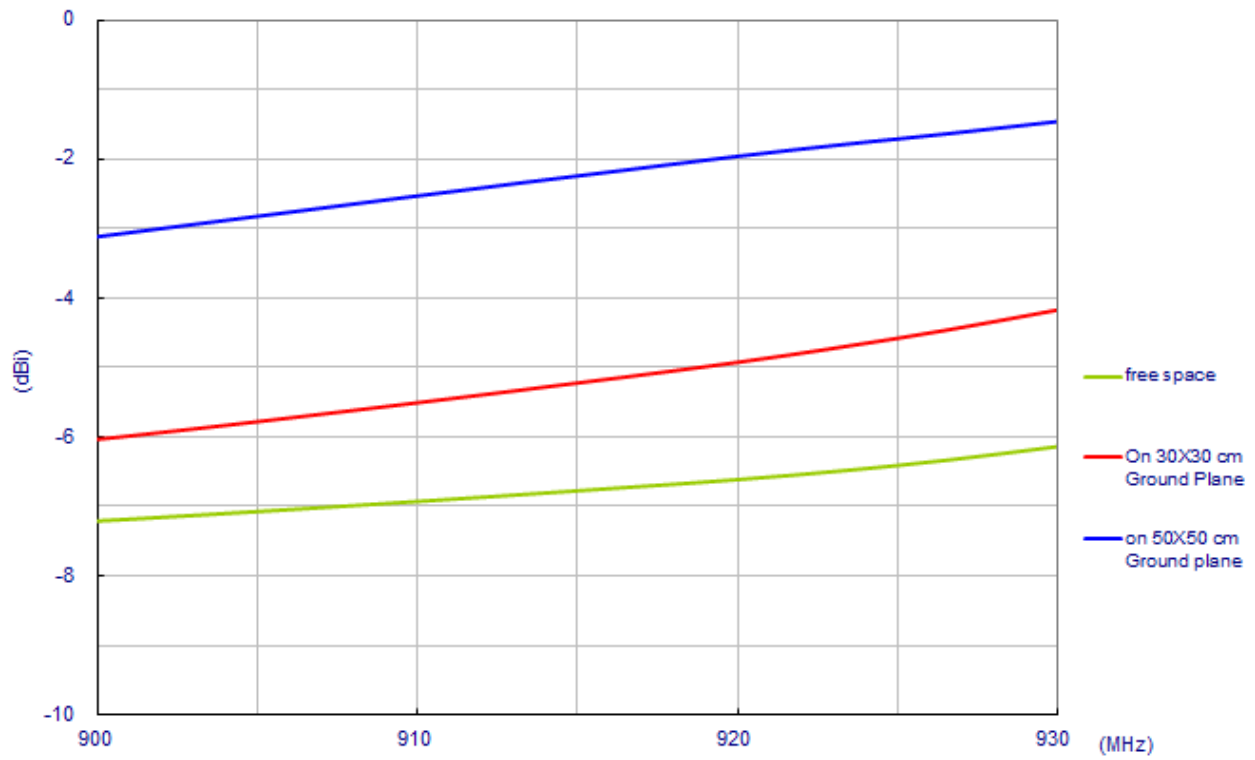

IV. Radiation Patterns

IV.1. Antenna setup (Free Space)

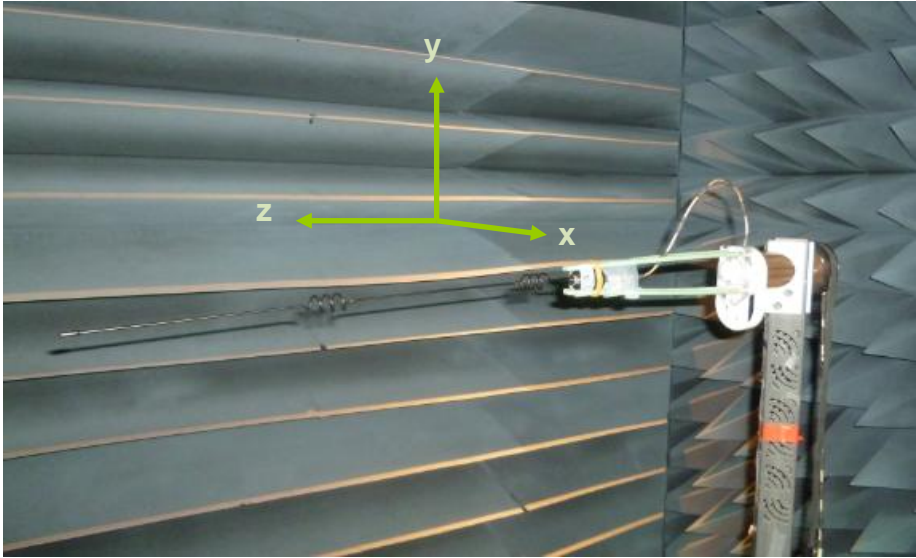

Radiation Pattern

XY plane

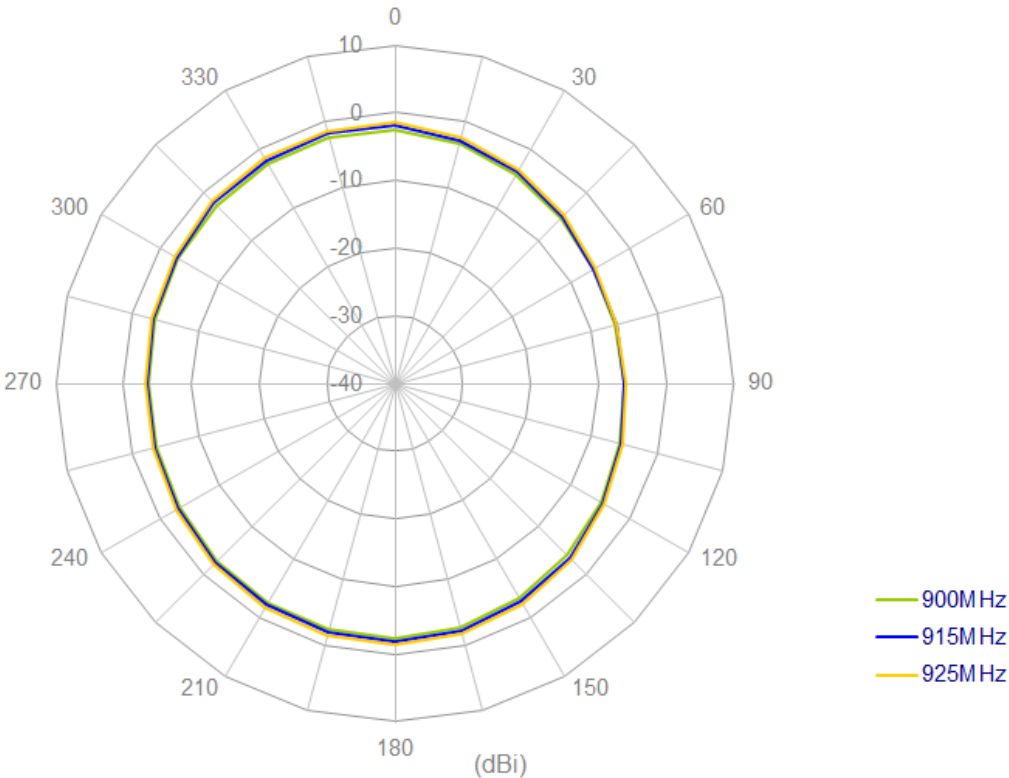

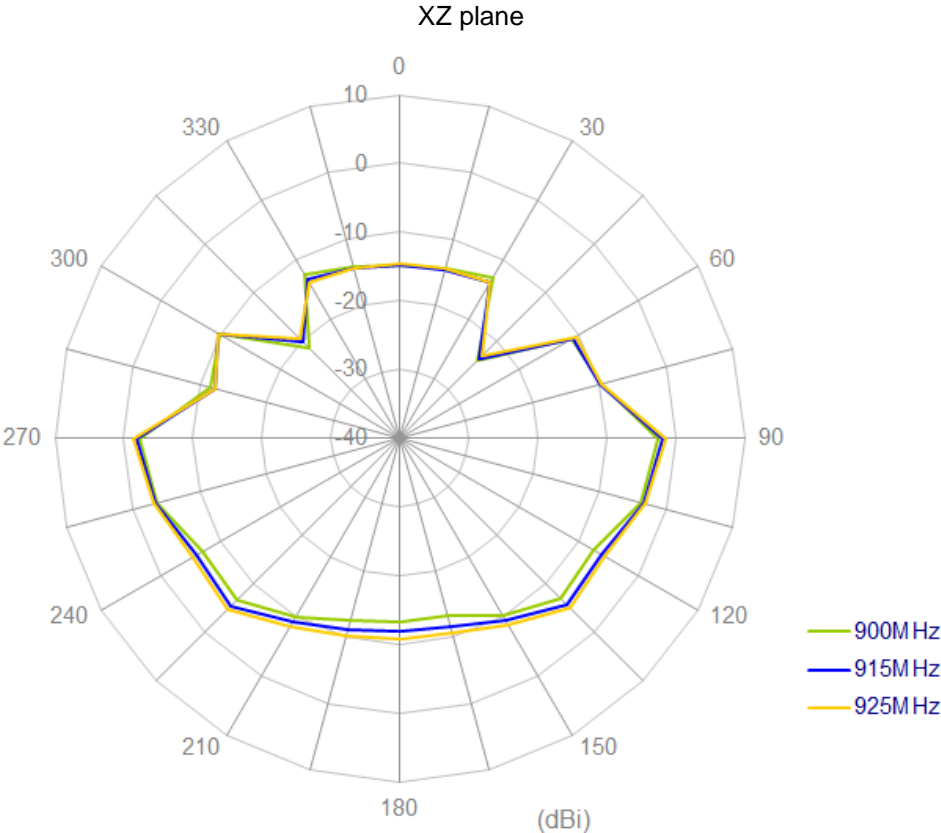

IV.2. Antenna setup (with 300x300mm ground plane)

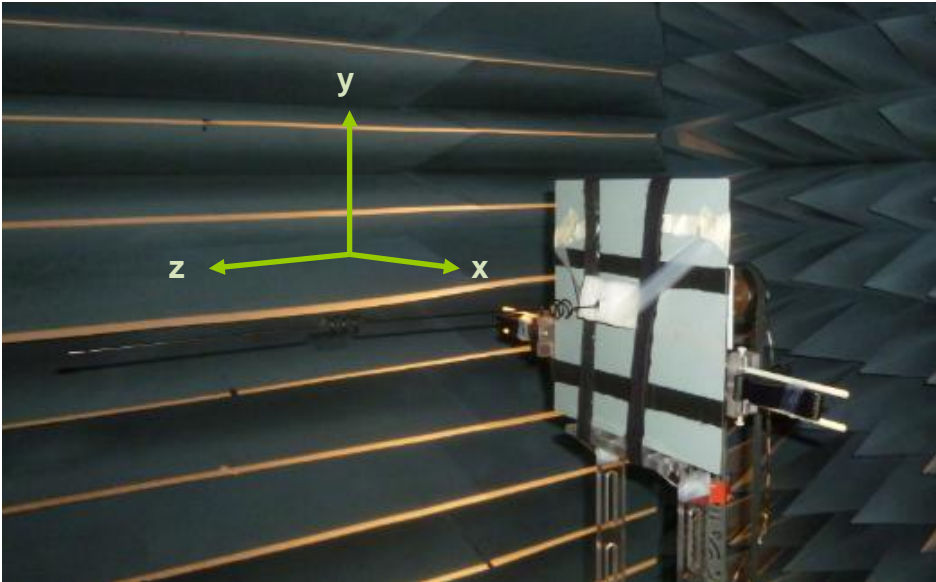

Radiation Pattern

XY plane

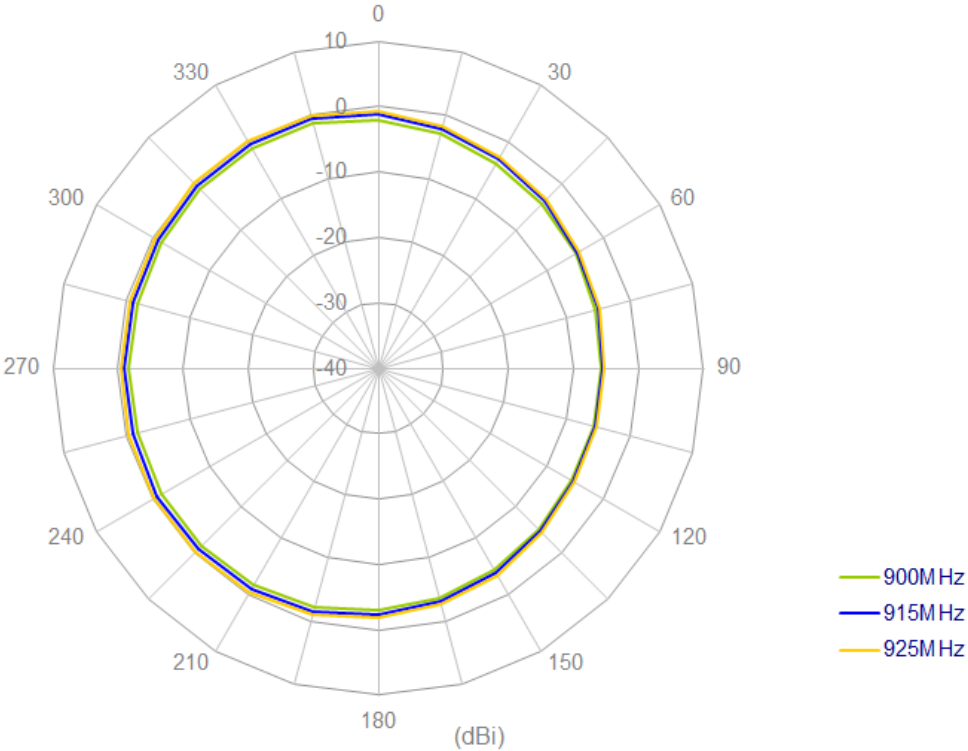



TAOGLAS®

XZ plane

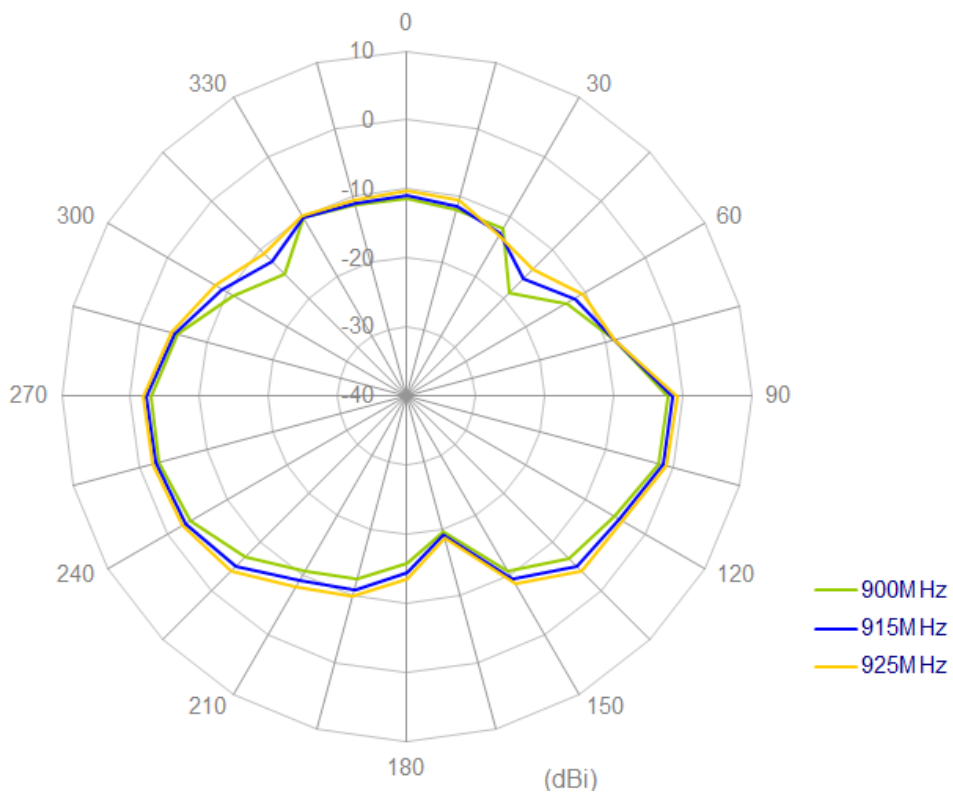

IV.3. Antenna setup (with 500x500mm ground plane)

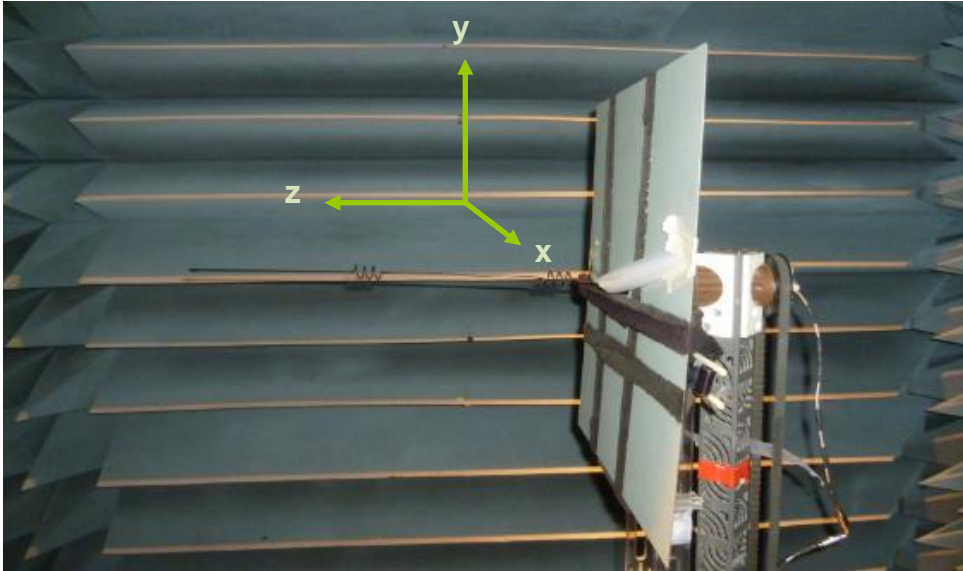

Radiation Pattern

XY plane

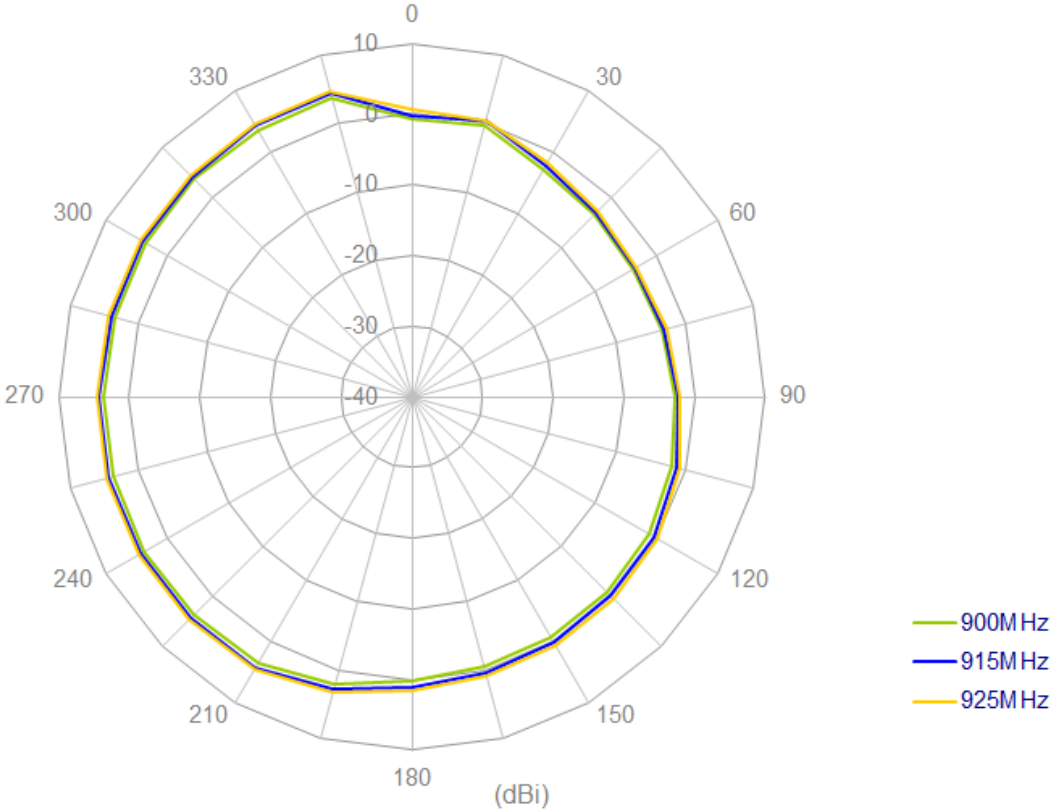

XZ plane

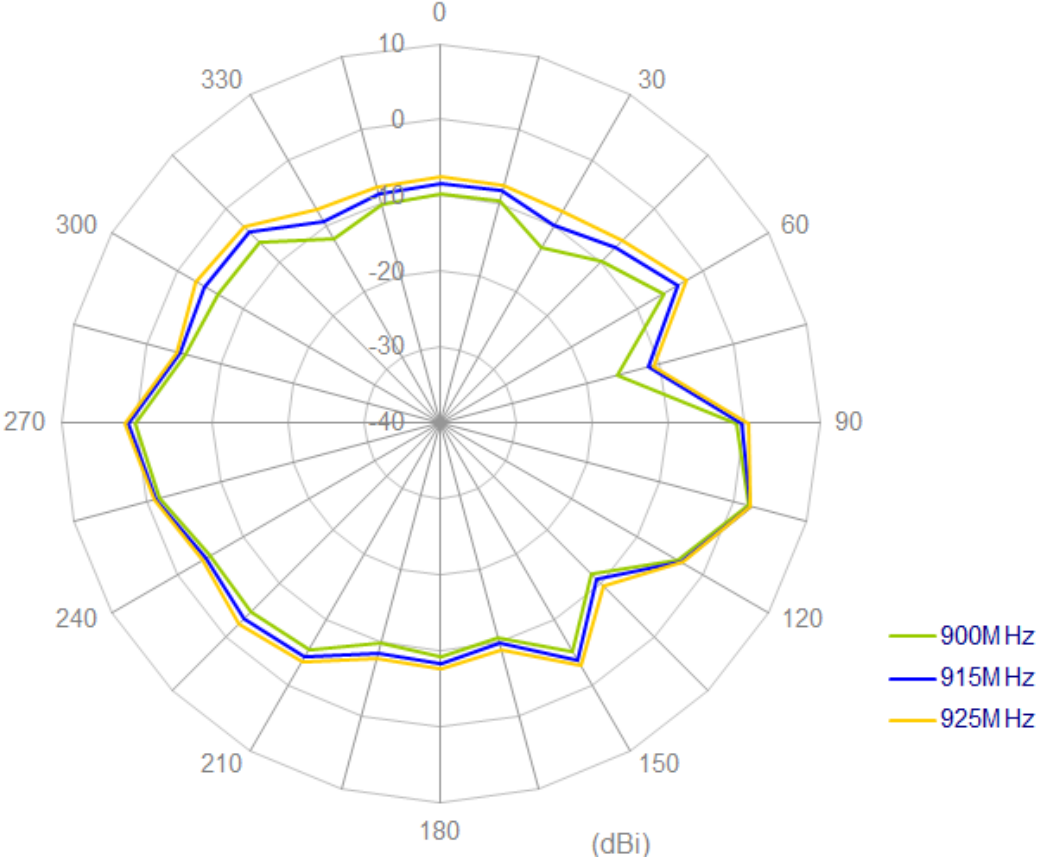

V. Drawing

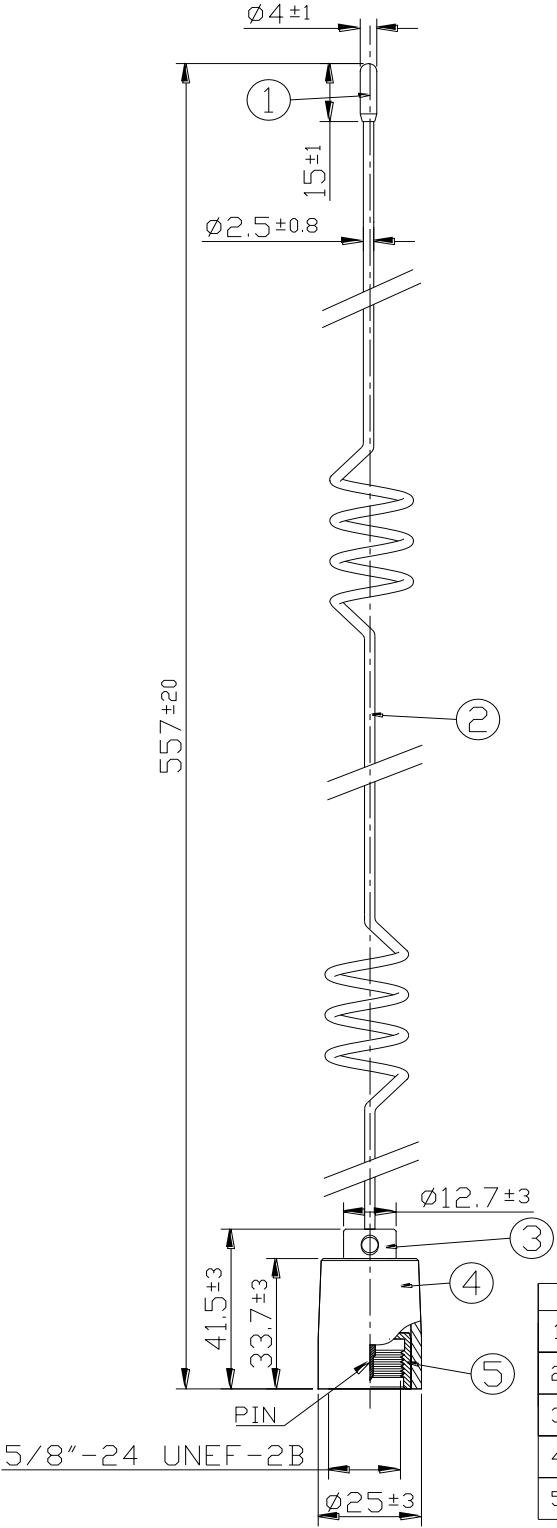

	Name	P/N	Material	Finish	QTY
1	Top Cap	000612C000002A	Brass	Black	1
2	Spring Antenna	000812C000002A	Brass	Black	1
3	Axis	000612C010002A	Brass	Ni Plated	1
4	NTYPE(M) Housing	000612C030002A	POM	Black	1
5	NTP(M)Thread	000612C020002A	Brass	Ni Plated	1

VI. Packaging

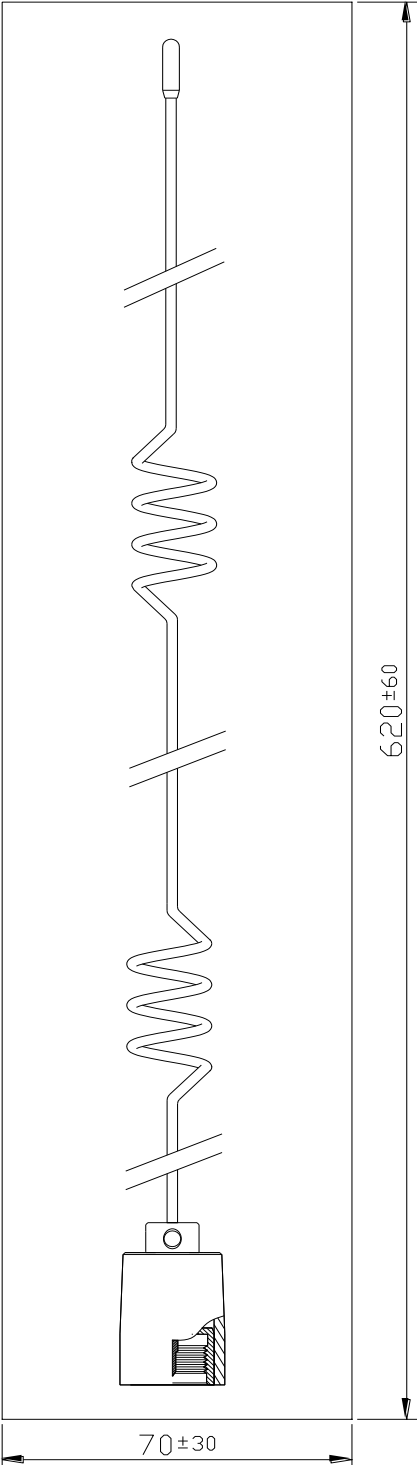

1PCS/BAG

Mouser Electronics

Authorized Distributor

Click to View Pricing, Inventory, Delivery & Lifecycle Information:

[Taoglas:](#)

[TI.16.5F11](#)